

Product catalogue

Anodes



Aluminium

Bolted

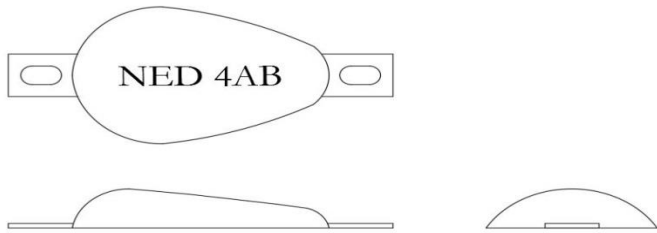
NED 4AB		Dimension	Metric	Imperial
		Net weight	: 0,4 kg	0,9 lb
		Gross weight	: 0,5 kg	1,1 lb
		Length	: 120 mm	4,7"
		Length with inserts	: 180 mm	7,1"
		Distance between holes	: 150 mm	5,9"
		Width top	: 80 mm	3,1"
		Width inserts	: 25 mm	1,0"
		Height	: 23 mm	0,9"
		Height inserts	: 3 mm	0,1"

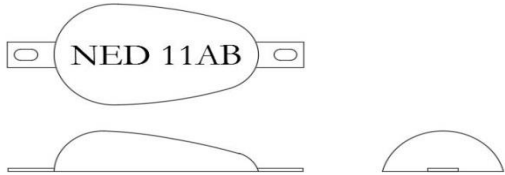
NED 11AB		Dimensions	Metric	Imperial
		Net weight	: 1,1 kg	2,4 lb
		Gross weight	: 1,3 kg	2,9 lb
		Length	: 170 mm	6,7"
		Length with inserts	: 245 mm	9,6"
		Distance between holes	: 215 mm	8,5"
		Width top	: 100 mm	3,9"
		Width inserts	: 25 mm	1,0"
		Height	: 40 mm	1,6"
		Height inserts	: 3 mm	0,1"

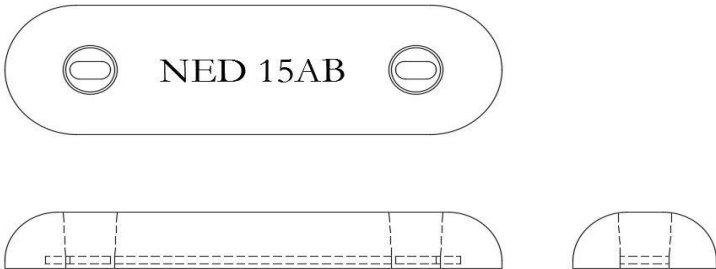
NED 15AB		Dimensions	Metric	Imperial
		Net weight	: 1,5 kg	3,3 lb
		Gross weight	: 1,7 kg	3,7 lb
		Length	: 305 mm	1' 0,0"
		Distance between holes	: 200 mm	7,9"
		Width top	: 88 mm	3,5"
		Width inserts	: 30 mm	1,2"
		Height	: 38 mm	1,5"
		Height inserts	: 5 mm	0,2"

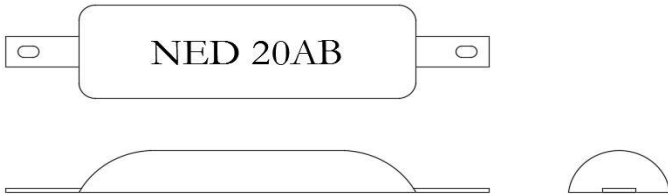
NED 20AB		Dimensions	Metric	Imperial
		Net weight	: 2,0 kg	4,4 lb
		Gross weight	: 2,4 kg	5,3 lb
		Length	: 300 mm	11,8"
		Length with inserts	: 430 mm	1' 4,9"
		Distance between holes	: 390 mm	1' 3,4"
		Width top	: 90 mm	3,5"
		Width inserts	: 30 mm	1,2"
		Height	: 40 mm	1,6"
		Height inserts	: 4 mm	0,2"

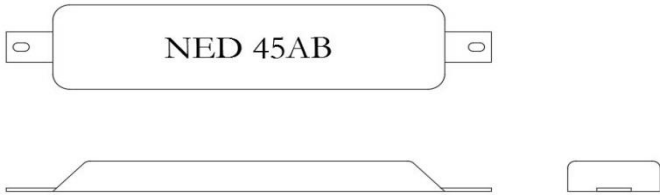
NED 45AB		Dimensions	Metric	Imperial
		Net weight	: 4,5 kg	9,9 lb
		Gross weight	: 5,0 kg	11,0 lb
		Length	: 465 mm	1' 6,3"
		Length with inserts	: 575 mm	1' 10,6"
		Distance between holes	: 540 mm	1' 9,3"
		Width top	: 110 mm	4,3"
		Width inserts	: 40 mm	1,6"
		Height	: 40 mm	1,6"
		Height inserts	: 5 mm	0,2"

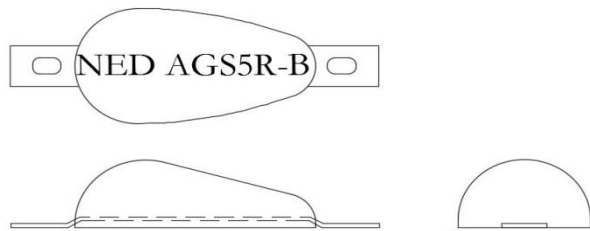
NED AGS5R-B

Dimensions	Metric	Imperial
Net weight	: 0,7 kg	1,5 lb
Gross weight	: 0,9 kg	2,0 lb
Length	: 160 mm	6,3"
Length with inserts	: 245 mm	9,6"
Distance between holes	: 196 mm	7,7"
Width top	: 88 mm	3,5"
Width inserts	: 30 mm	1,2"
Height	: 50 mm	2,0"
Height inserts	: 3 mm	0,1"

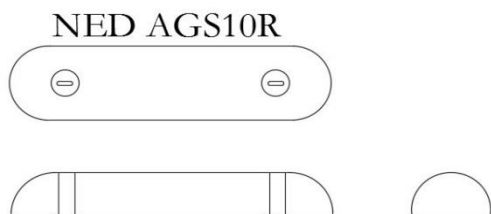
NED AGS10R

Dimensions	Metric	Imperial
Net weight	: 1,8 kg	4,0 lb
Gross weight	: 2,0 kg	4,4 lb
Length	: 305 mm	1' 0,0"
Distance between holes	: 200 mm	7,9"
Width top	: 74 mm	2,9"
Height	: 44 mm	1,7"

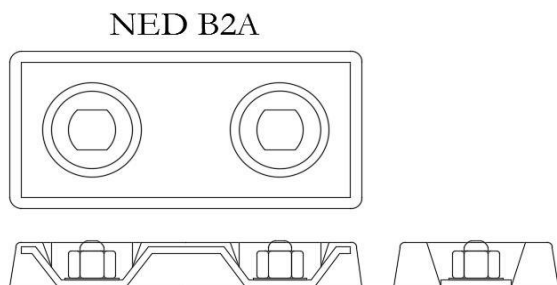
NED B2A

Dimensions	Metric	Imperial
Net weight	: 0,5 kg	1,1 lb
Gross weight	: 0,6 kg	1,3 lb
Length	: 150 mm	5,9"
Distance between holes	: 80 mm	3,1"
Width top	: 70 mm	2,8"
Width inserts	: 30 mm	1,2"
Height	: 20 mm	0,8"
Height inserts	: 3 mm	0,1"

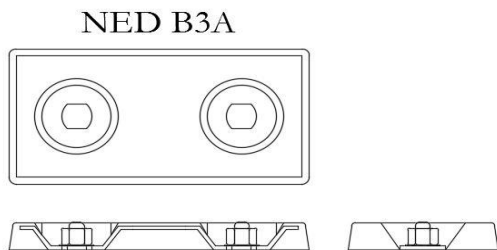
NED B3A

Dimensions	Metric	Imperial
Net weight	: 1,1 kg	2,4 lb
Gross weight	: 1,2 kg	2,6 lb
Length	: 200 mm	7,9"
Distance between holes	: 110 mm	4,3"
Width top	: 100 mm	3,9"
Width inserts	: 30 mm	1,2"
Height	: 20 mm	0,8"
Height inserts	: 3 mm	0,1"

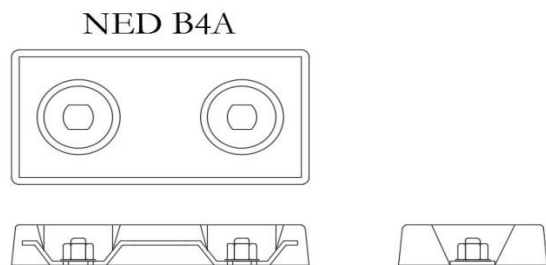
NED B4A

Dimensions	Metric	Imperial
Net weight	: 1,4 kg	3,1 lb
Gross weight	: 1,5 kg	3,3 lb
Length	: 200 mm	7,9"
Distance between holes	: 110 mm	4,3"
Width top	: 100 mm	3,9"
Width inserts	: 30 mm	1,2"
Height	: 30 mm	1,2"
Height inserts	: 3 mm	0,1"

NED B5A

NED B5A

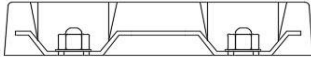
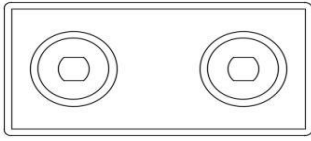
**Dimensions**

	Metric	Imperial
Net weight	: 1,8 kg	4,0 lb
Gross weight	: 1,9 kg	4,2 lb
Length	: 200 mm	7,9"
Distance between holes	: 110 mm	4,3"
Width top	: 100 mm	3,9"
Width inserts	: 30 mm	1,2"
Height	: 40 mm	1,6"
Height inserts	: 3 mm	0,1"

NED B8A

NED B8A

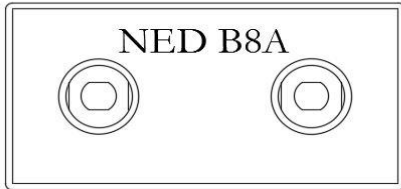
**Dimensions**

	Metric	Imperial
Net weight	: 2,7 kg	6,0 lb
Gross weight	: 3,0 kg	6,6 lb
Length	: 300 mm	11,8"
Distance between holes	: 160 mm	6,3"
Width top	: 150 mm	5,9"
Width inserts	: 50 mm	2,0"
Height	: 25 mm	1,0"
Height inserts	: 5 mm	0,2"

NED B9A

NED B9A

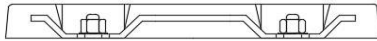
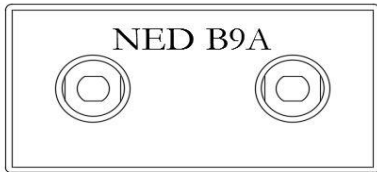
**Dimensions**

	Metric	Imperial
Net weight	: 3,0 kg	6,6 lb
Gross weight	: 3,3 kg	7,3 lb
Length	: 300 mm	11,8"
Distance between holes	: 160 mm	6,3"
Width top	: 150 mm	5,9"
Width inserts	: 50 mm	2,0"
Height	: 30 mm	1,2"
Height inserts	: 5 mm	0,2"

NED B10A

NED B10A

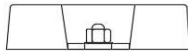
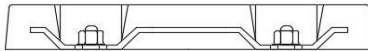
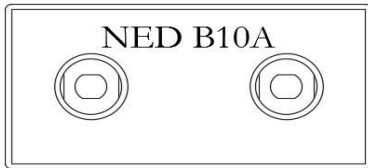
**Dimensions**

	Metric	Imperial
Net weight	: 4,2 kg	9,3 lb
Gross weight	: 4,5 kg	9,9 lb
Length	: 300 mm	11,8"
Distance between holes	: 160 mm	6,3"
Width top	: 150 mm	5,9"
Width inserts	: 50 mm	2,0"
Height	: 40 mm	1,6"
Height inserts	: 5 mm	0,2"

NED B11A

NED B11A

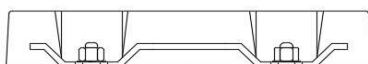
**Dimensions**

	Metric	Imperial
Net weight	: 5,1 kg	11,2 lb
Gross weight	: 5,4 kg	11,9 lb
Length	: 300 mm	11,8"
Distance between holes	: 160 mm	6,3"
Width top	: 150 mm	5,9"
Width inserts	: 50 mm	2,0"
Height	: 50 mm	2,0"
Height inserts	: 5 mm	0,2"

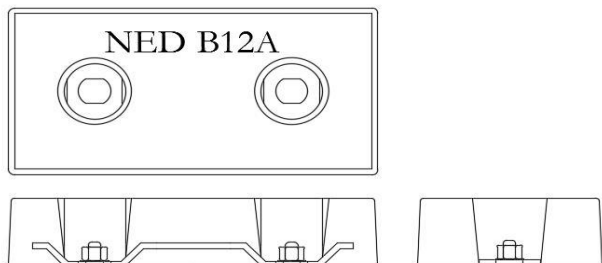
NED B12A

Dimensions	Metric	Imperial
Net weight	: 6,3 kg	13,9 lb
Gross weight	: 6,6 kg	14,6 lb
Length	: 300 mm	11,8"
Distance between holes	: 160 mm	6,3"
Width top	: 150 mm	5,9"
Width inserts	: 50 mm	2,0"
Height	: 60 mm	2,4"
Height inserts	: 5 mm	0,2"

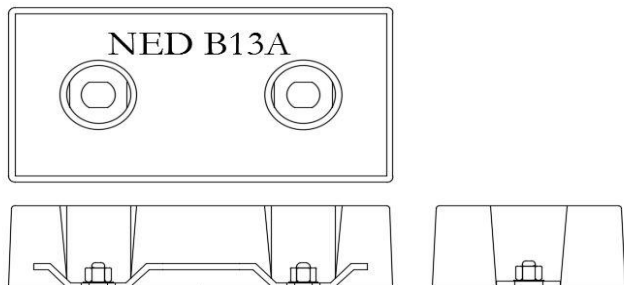
NED B13A

Dimensions	Metric	Imperial
Net weight	: 7,4 kg	16,3 lb
Gross weight	: 7,7 kg	17,0 lb
Length	: 300 mm	11,8"
Distance between holes	: 160 mm	6,3"
Width top	: 150 mm	5,9"
Width inserts	: 50 mm	2,0"
Height	: 70 mm	2,8"
Height inserts	: 5 mm	0,2"

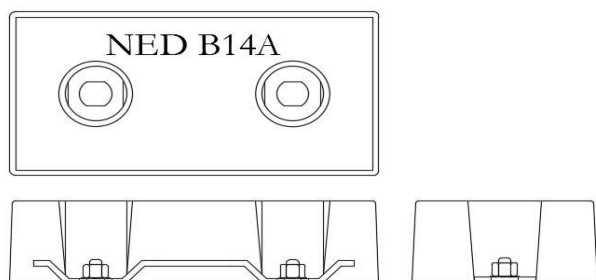
NED B14A

Dimensions	Metric	Imperial
Net weight	: 8,1 kg	17,9 lb
Gross weight	: 8,5 kg	18,7 lb
Length	: 300 mm	11,8"
Distance between holes	: 160 mm	6,3"
Width top	: 150 mm	5,9"
Width inserts	: 50 mm	2,0"
Height	: 75 mm	3,0"
Height inserts	: 5 mm	0,2"

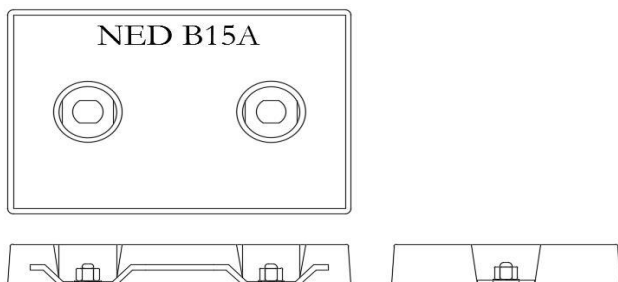
NED B15A

Dimensions	Metric	Imperial
Net weight	: 5,3 kg	11,7 lb
Gross weight	: 5,6 kg	12,3 lb
Length	: 300 mm	11,8"
Distance between holes	: 160 mm	6,3"
Width top	: 200 mm	7,9"
Width inserts	: 50 mm	2,0"
Height	: 40 mm	1,6"
Height inserts	: 5 mm	0,2"

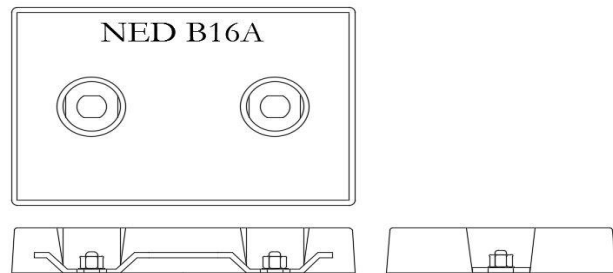
NED B16A

Dimensions	Metric	Imperial
Net weight	: 6,3 kg	13,9 lb
Gross weight	: 6,6 kg	14,6 lb
Length	: 300 mm	11,8"
Distance between holes	: 160 mm	6,3"
Width top	: 200 mm	7,9"
Width inserts	: 50 mm	2,0"
Height	: 45 mm	1,8"
Height inserts	: 5 mm	0,2"

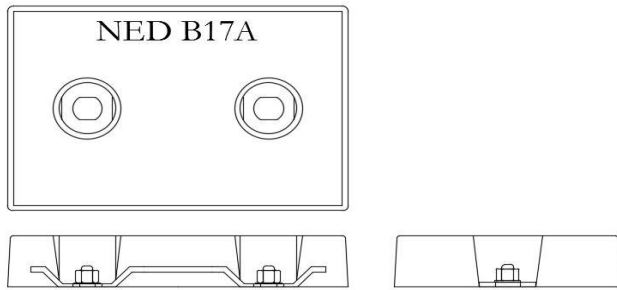
NED B17A

Dimensions	Metric	Imperial
Net weight	: 7,3 kg	16,1 lb
Gross weight	: 7,6 kg	16,8 lb
Length	: 300 mm	11,8"
Distance between holes	: 160 mm	6,3"
Width top	: 200 mm	7,9"
Width inserts	: 50 mm	2,0"
Height	: 50 mm	2,0"
Height inserts	: 5 mm	0,2"

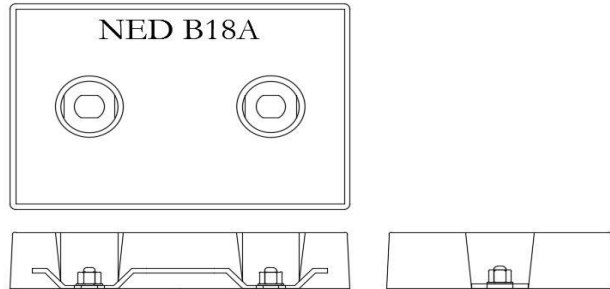
NED B18A

Dimensions	Metric	Imperial
Net weight	: 8,3 kg	18,3 lb
Gross weight	: 8,6 kg	19,0 lb
Length	: 300 mm	11,8"
Distance between holes	: 160 mm	6,3"
Width top	: 200 mm	7,9"
Width inserts	: 50 mm	2,0"
Height	: 55 mm	2,2"
Height inserts	: 5 mm	0,2"

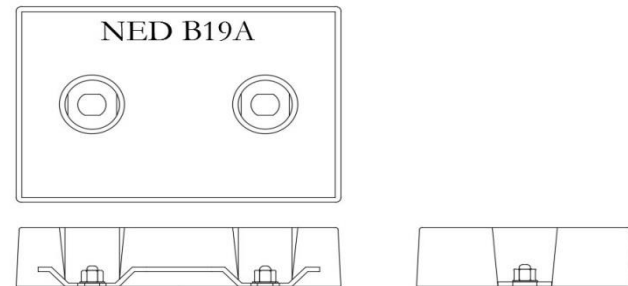
NED B19A

Dimensions	Metric	Imperial
Net weight	: 9,3 kg	20,5 lb
Gross weight	: 9,6 kg	21,2 lb
Length	: 300 mm	11,8"
Distance between holes	: 160 mm	6,3"
Width top	: 200 mm	7,9"
Width inserts	: 50 mm	2,0"
Height	: 60 mm	2,4"
Height inserts	: 5 mm	0,2"

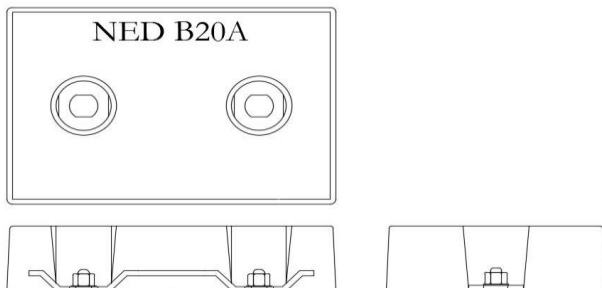
NED B20A

Dimensions	Metric	Imperial
Net weight	: 10,3 kg	22,7 lb
Gross weight	: 10,6 kg	23,4 lb
Length	: 300 mm	11,8"
Distance between holes	: 160 mm	6,3"
Width top	: 200 mm	7,9"
Width inserts	: 50 mm	2,0"
Height	: 65 mm	2,6"
Height inserts	: 5 mm	0,2"

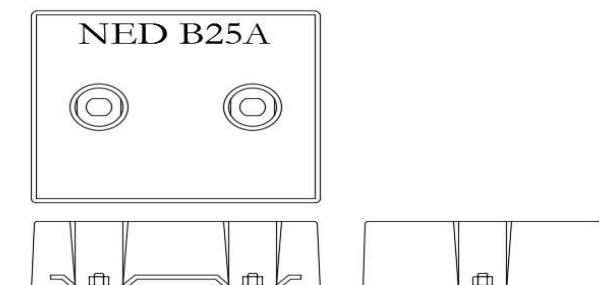
NED B25A

Dimensions	Metric	Imperial
Net weight	: 15,0 kg	33,1 lb
Gross weight	: 15,5 kg	34,2 lb
Length	: 300 mm	11,8"
Distance between holes	: 160 mm	6,3"
Width top	: 250 mm	9,8"
Width inserts	: 50 mm	2,0"
Height	: 90 mm	3,5"
Height inserts	: 5 mm	0,2"

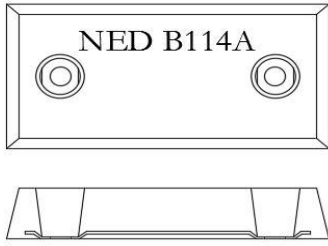
NED B114A

Dimensions	Metric	Imperial
Net weight	: 11,4 kg	25,1 lb
Gross weight	: 11,8 kg	26,0 lb
Length	: 400 mm	1' 3,7"
Distance between holes	: 267 mm	10,5"
Width top	: 200 mm	7,9"
Width inserts	: 50 mm	2,0"
Height	: 70 mm	2,8"
Height inserts	: 3 mm	0,1"

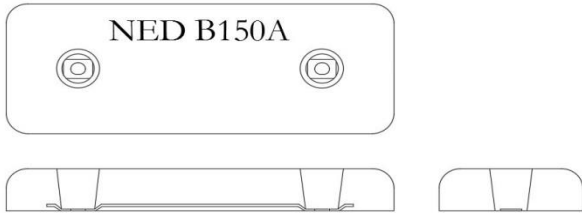
NED B150A

Dimensions	Metric	Imperial
Net weight	: 15,0 kg	33,1 lb
Gross weight	: 15,6 kg	34,4 lb
Length	: 540 mm	1' 9,3"
Distance between holes	: 340 mm	1' 1,4"
Width top	: 200 mm	7,9"
Width inserts	: 30 mm	1,2"
Height	: 65 mm	2,6"
Height inserts	: 3 mm	0,1"

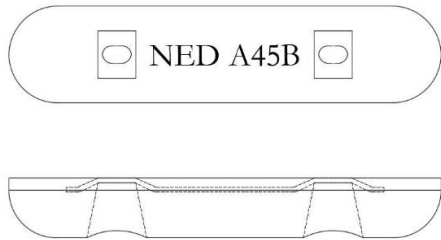
NED A45B

Dimensions	Metric	Imperial
Net weight	: 4,5 kg	9,9 lb
Gross weight	: 5,0 kg	11,0 lb
Length	: 457 mm	1' 5,9"
Distance between holes	: 229 mm	9"
Width top	: 102 mm	4"
Width inserts	: 40 mm	1,6"
Height	: 63 mm	2,5"
	:	

PERFECTION IN INSPECTION

PERFECTION FOR PROTECTION



- * Ultrasonic Thickness measurements
- * New Building Inspections
- * Coating Inspections
- * Pré Conditional Survey
- * Dry-Dock Supervision
- * Superintendence
- * Hull Condition Monitoring
- * P&S Surveys
- * Hatch Tightness Testing
- * Leak Detection
- * Reporting
- * NDT Inspections

- * Magnetic Core Drilling
Technology and Products
- * Workshop Equipment



- * Sacrificial Anodes
- * Maritime Products

Version 1.0

Ned Marine Services B.V. – Tinstraat 109 – 2984 AN Ridderkerk – The Netherlands - Phone 0031 (0) 180 420 055 – Fax 0031 (0) 180 499 810

E-mail info@nedmarine.com – Website www.nedmarine.com – www.usaf-nedmarine.com

Registered Chamber of Commerce (KvK) Rotterdam 50358766 ABN AMRO Bank no. 401276015 VAT no. NL 822692144B01

International Banking Account no. NL25ABNA0401276015 – Swift no. ABNANL2A